

HIGH PRESSURE BLOWERS  
CENTRIFUGAL AND AXIAL FANS  
AIR FILTERS  
AIR HANDLING UNITS  
TUNNEL ENGINEERING



**SAVIO** S.r.l.



**VENTILATORI CENTRIFUGHI**  
**CENTRIFUGAL FANS**  
**VENTILATEURS CENTRIFUGES**  
**ZENTRIFUGAL VENTILATOREN**

**Serie SCRK / SFRK**



**Serie CA-SCRK**

**Cabina afona**

**Soundproof cabin**

**Cabine aphone**

**Schalltote kabine**



<b>INDICE</b>		<b>SUMMARY</b>	
CONCETTI GENERALI SUI VENTILATORI	Pag. <b><u>4</u></b>	GENERAL PRINCIPLES OF THE FAN DESIGN	Pag. <b><u>5</u></b>
CARATTERISTICHE TECNICHE	Pag. <b><u>8</u></b>	TECHNICAL FEATURES	Pag. <b><u>8</u></b>
TABELLA ORIENTAMENTI	Pag. <b><u>8</u></b>	TABLE OF DISCHARGE POSITION	Pag. <b><u>8</u></b>
DIMENSIONI D'INGOMBRO E PESI SCRK-SFRK	Pag. <b><u>9</u></b>	OVERALL DIMENSIONS AND WEIGHT SCRK-SFRK	Pag. <b><u>9</u></b>
TABELLE PRESTAZIONALI SCRK	Pag. <b><u>10</u></b>	PERFORMANCE TABLES SCRK	Pag. <b><u>10</u></b>
TABELLE PRESTAZIONALI SFRK	Pag. <b><u>12</u></b>	PERFORMANCE TABLES SFRK	Pag. <b><u>12</u></b>
ACCESSORI	Pag. <b><u>14</u></b>	ACCESSORIES	Pag. <b><u>14</u></b>

<b>SOMMAIRE</b>		<b>INHALTSANGABE</b>	
PRINCIPES GENERAUX DES VENTILATEURS	Pag. <b><u>6</u></b>	ALLGEMEINE ANGABEN ÜBER DIE VENTILATOREN	Pag. <b><u>7</u></b>
CARACTERISTIQUES TECHNIQUES	Pag. <b><u>8</u></b>	TECHNISCHE MERKMALE	Pag. <b><u>8</u></b>
TABLEAU D'ORIENTATION	Pag. <b><u>8</u></b>	TABELLE DER GAHÄUSESSTELLUNGEN	Pag. <b><u>8</u></b>
DIM.. D'ENCOMBREMENT ET POIDS SCRK-SFRK	Pag. <b><u>9</u></b>	ABMESSUNGEN UND GEWICHTE SCRK-SFRK	Pag. <b><u>9</u></b>
TABLEAUX DES PERFORMANCES SCRK	Pag. <b><u>10</u></b>	LEISTUNGSTABELLE SCRK	Pag. <b><u>10</u></b>
TABLEAUX DES PERFORMANCES SFRK	Pag. <b><u>12</u></b>	LEISTUNGSTABELLE SFRK	Pag. <b><u>12</u></b>
ACCESSORIES	Pag. <b><u>14</u></b>	ZUBEHÖRTEILE	Pag. <b><u>14</u></b>

## CONCETTI GENERALI SUI VENTILATORI

### 1) PARAMETRI

I principali parametri che distinguono un ventilatore sono quattro:

Portata (V)                      Pressione (p)                      Rendimento (%)                      Velocità di rotazione (n° min.<sup>-1</sup>)

#### 1.1) Portata:

La portata è la quantità di fluido movimentata dal ventilatore, in termini di volume, nell'unità di tempo e si esprime normalmente in m<sup>3</sup>/h, m<sup>3</sup>/min., m<sup>3</sup>/sec.

#### 1.2) Pressione:

La pressione totale (pt) è la somma tra la pressione statica (pst), ovvero l'energia necessaria a vincere gli attriti opposti dall'impianto e la pressione dinamica (pd) o energia cinetica impressa al fluido in movimento (pt = pst + pd).

La pressione dinamica dipende dalla velocità (v) e dal peso specifico del fluido (y).

$$pd = \frac{1}{2} \cdot y \cdot v^2$$

Dove:      pd = pressione dinamica (Pa)  
               y = peso specifico del fluido (Kg/m<sup>3</sup>)  
               v = velocità del fluido alla bocca del ventilatore interessata dall'impianto (m/sec)

$$v = \frac{V}{A}$$

Dove:      V = portata (m<sup>3</sup>/sec)  
               A = sezione della bocca interessata dall'impianto (m<sup>2</sup>)  
               v = velocità del fluido alla bocca del ventilatore interessata dall'impianto (m/sec)

#### 1.3) Rendimento:

Il rendimento è il rapporto tra l'energia resa dal ventilatore e quella assorbita dal motore che aziona il ventilatore stesso.

$$\eta = \frac{V \cdot pt}{1,02 \cdot P}$$

Dove:      η = rendimento (%)                      P = potenza assorbita (kW)  
               V = portata (m<sup>3</sup>/sec)                      pt = pressione totale (daPa)

#### 1.4) Velocità di rotazione:

La velocità di rotazione è il nr. di giri che la girante del ventilatore deve compiere per fornire le caratteristiche richieste. Al variare del nr. dei giri (n), mantenendo costante il peso specifico del fluido (y), si ottengono le seguenti variazioni:

La portata (V) è direttamente proporzionale alla velocità di rotazione quindi:

$$V_1 = V \cdot \frac{n_1}{n}$$

Dove:      n = velocità di rot.ne      V<sub>1</sub> = nuova portata ottenuta al variare della velocità di rot.  
               V = portata                      n<sub>1</sub> = nuova velocità di rotazione

La pressione totale (pt) varia con il quadrato del rapporto delle velocità di rotazione quindi:

$$pt_1 = pt \cdot \left(\frac{n_1}{n}\right)^2$$

Dove:      n = velocità di rot.ne      pt<sub>1</sub> = nuova pressione tot. ottenuta al variare della vel. di rot.  
               pt = pressione tot.                      n<sub>1</sub> = nuova velocità di rotazione

La potenza assorbita (P) varia con il cubo del rapporto delle velocità di rotazione quindi:

$$P_1 = P \cdot \left(\frac{n_1}{n}\right)^3$$

Dove:      n = velocità di rot.ne      P<sub>1</sub> = nuova potenza ass. ottenuta al variare della vel. di rot.  
               P = potenza ass.                      n<sub>1</sub> = nuova velocità di rotazione

## 2) DIMENSIONAMENTO

Le caratteristiche da noi espresse nelle tabelle che seguono, sono riferite al funzionamento con fluido (aria) alla temperatura di + 15°C e con pressione barometrica di 760 mm Hg (peso specifico = 1.226 kg/m<sup>3</sup>).

I dati relativi alla rumorosità sono riferiti ad una misurazione in campo libero, alla distanza di 1,5 m. con ventilatore funzionante alla portata di massimo rendimento.

I valori riportati sono soggetti alle seguenti tolleranze: portata ± 5% - rumorosità +3 dB(A).

Quando le condizioni del fluido trasportato differiscono da quelle sopra citate è necessario tenere conto che temperatura e pressione barometrica, influenzano direttamente il peso specifico del fluido stesso.

Al variare del peso specifico, la portata (V) in termini di volume rimane costante, la pressione (pt) e la potenza (P) varieranno direttamente con il rapporto dei pesi specifici.

$$pt_1 = \frac{y_1}{y} \cdot pt \quad \left| \quad P_1 = \frac{y_1}{y} \cdot P$$

Dove:      pt = pressione totale      pt<sub>1</sub> = nuova pressione tot. ottenuta al variare del peso specifico  
               P = potenza assorbita      P<sub>1</sub> = nuova potenza ass. ottenuta al variare del peso specifico  
               y = peso spec. fluido                      y<sub>1</sub> = nuovo peso specifico del fluido

Il peso specifico (y) si può calcolare con la seguente formula:

$$y = \frac{Pb \cdot 13,59}{29,27 \cdot (273+t)}$$

Dove:      y = peso specifico dell'aria a t °C (Kg/m<sup>3</sup>)  
               Pb = pressione barometrica (mm Hg)  
               t = temp. del fluido (°C)                      13,59 = peso specifico mercurio a 0° C (kg/dm<sup>3</sup>)

Per maggior facilità di calcolo, riportiamo il peso dell'aria alle varie temperature ed alle varie altitudini:

		Temperatura																				
		-40°C	-20°C	0°C	10°C	15°C	20°C	30°C	40°C	50°C	60°C	70°C	80°C	90°C	100°C	120°C	150°C	200°C	250°C	300°C	350°C	400°C
Altitudine m s.l.m.	0	1,514	1,395	1,293	1,247	1,226	1,204	1,165	1,127	1,092	1,060	1,029	1,000	0,972	0,946	0,898	0,834	0,746	0,675	0,616	0,566	0,524
	500	1,435	1,321	1,225	1,181	1,161	1,141	1,103	1,068	1,035	1,004	0,975	0,947	0,921	0,896	0,851	0,790	0,707	0,639	0,583	0,537	0,497
	1000	1,355	1,248	1,156	1,116	1,096	1,078	1,042	1,009	0,977	0,948	0,920	0,894	0,870	0,846	0,803	0,746	0,667	0,604	0,551	0,507	0,469
	1500	1,275	1,175	1,088	1,050	1,032	1,014	0,981	0,949	0,920	0,892	0,866	0,842	0,819	0,797	0,756	0,702	0,628	0,568	0,519	0,477	0,442
	2000	1,196	1,101	1,020	0,984	0,967	0,951	0,919	0,890	0,862	0,837	0,812	0,789	0,767	0,747	0,709	0,659	0,589	0,533	0,486	0,447	0,414
2500	1,116	1,028	0,952	0,919	0,903	0,887	0,858	0,831	0,805	0,781	0,758	0,737	0,716	0,697	0,662	0,615	0,550	0,497	0,454	0,417	0,386	

## GENERAL PRINCIPLES OF THE FAN DESIGN

### 1) PARAMETERS

The main parameters, characteristic to a fan, are four in number:

Capacity (V)                                  Pressure (p)                                  Efficiency (%)                                  Speed of rotation (n° min.<sup>-1</sup>)

#### 1.1) Capacity:

The capacity is the quantity of fluid moved by the fan, in volume, within a unit of time, and it is usually expressed in m<sup>3</sup>/h, m<sup>3</sup>/min., m<sup>3</sup>/sec.

#### 1.2) Pressure:

The total pressure (pt) is the sum of the static pressure (pst), i.e. the energy required to withstand opposite frictions from the system, and the dynamic pressure (pd) or kinetic energy imparted to the moving fluid (pt = pst + pd).

The dynamic pressure depends on both fluid speed (v) and specific gravity (y).

$$pd = \frac{1}{2} \cdot y \cdot v^2$$

Where:      pd = dynamic pressure (Pa)  
                     y = specific gravity of the fluid (Kg/m<sup>3</sup>)  
                     v = fluid speed at the fan opening worked by the system (m/sec)

$$v = \frac{V}{A}$$

Where:      V = capacity (m<sup>3</sup>/sec)  
                     A = gauge of the opening worked by the system (m<sup>2</sup>)  
                     v = fluid speed at the fan opening worked by the system (m/sec)

#### 1.3) Efficiency:

The efficiency is the ratio between the energy yielded by the fan and the energy input to the fan driving motor.

$$\eta = \frac{V \cdot pt}{1,02 \cdot P}$$

Where:      η = efficiency = (%)                                  P = absorbed power (kW)  
                     V capacity (m<sup>3</sup>/sec)                                  pt = total pressure (daPa)

#### 1.4) Speed of rotation:

The speed of rotation is the number of revolutions the fan impeller has to run in order to meet the performance requirements.

As the number of revolutions varies (n), while the fluid specific gravity keeps steady (y), the following variations take place:

The capacity (V) is directly proportional to the speed of rotation, therefore :

$$V_1 = V \cdot \frac{n_1}{n}$$

Where:      n = speed of rotation      V<sub>1</sub> = new capacity obtained upon varying of the speed of rot.  
                     V = capacity                                  n<sub>1</sub> = new speed of rotation

The total pressure (pt) varies as a function of the squared ratio of the speeds of rotation; therefore:

$$pt_1 = pt \cdot \left(\frac{n_1}{n}\right)^2$$

Where:      n = speed of rotation      pt<sub>1</sub> = new total pressure obtained upon varying of the speed of rot.  
                     pt = total pressure                                  n<sub>1</sub> = new speed of rotation

The absorbed power (P) varies as a function of the cubed ratio of the speeds of rotation therefore:

$$P_1 = P \cdot \left(\frac{n_1}{n}\right)^3$$

Where:      n = speed of rotation      P<sub>1</sub> = new electrical input obtained upon varying of the speed of rot.  
                     P = abs. power                                  n<sub>1</sub> = new speed of rotation

### 2) SIZING

The characteristics expressed in the following tables are referred to operation with fluid (air) at +15°C temperature and 760 mm Hg barometric pressure (specific gravity = 1.226 kg/m<sup>3</sup>).

The noise data are referred to a measurement taken in free field, at 1.5 m distance, with fan running at the maximum rate of efficiency.

The above-mentioned values undertake the following tolerance: ± 5% capacity - +3 dB(A) noise.

When the conveyed fluid conditions differ from the above-mentioned ones, the following should be considered, that the temperature and the barometric pressure are directly affecting the specific gravity of the fluid.

As the specific gravity varies, the volume flowrate (V) keeps on constant, and the pressure (pt) and power (P) vary directly as a function of the ratio of the specific gravities.

$$pt_1 = \frac{y_1}{y} \cdot pt \quad \left| \quad P_1 = \frac{y_1}{y} \cdot P \right.$$

Where:      pt = total pressure                                  pt<sub>1</sub> = new total pressure obtained upon varying the specific gravity  
                     P = absorbed power                                  P<sub>1</sub> = new abs. power obtained upon varying the specific gravity  
                     y = fluid spec. gravity                                  y<sub>1</sub> = new specific gravity of the fluid

The specific gravity (y) may be calculated with the following formula:

$$y = \frac{Pb \cdot 13,59}{29,27 \cdot (273+t)}$$

Where:      y = air specific gravity at t °C (Kg/m<sup>3</sup>)  
                     Pb = barometric pressure (mm Hg)  
                     t = fluid temp. (°C)                                  13,59 = mercury specific gravity at 0° C (kg/dm<sup>3</sup>)

For ease of calculation, the air weight at various temperatures and heights a.s.l. have been included in the table below:

		Temperature																				
		-40°C	-20°C	0°C	10°C	15°C	20°C	30°C	40°C	50°C	60°C	70°C	80°C	90°C	100°C	120°C	150°C	200°C	250°C	300°C	350°C	400°C
Height above sea level in meters	0	1,514	1,395	1,293	1,247	1,226	1,204	1,165	1,127	1,092	1,060	1,029	1,000	0,972	0,946	0,898	0,834	0,746	0,675	0,616	0,566	0,524
	500	1,435	1,321	1,225	1,181	1,161	1,141	1,103	1,068	1,035	1,004	0,975	0,947	0,921	0,896	0,851	0,790	0,707	0,639	0,583	0,537	0,497
	1000	1,355	1,248	1,156	1,116	1,096	1,078	1,042	1,009	0,977	0,948	0,920	0,894	0,870	0,846	0,803	0,746	0,667	0,604	0,551	0,507	0,469
	1500	1,275	1,175	1,088	1,050	1,032	1,014	0,981	0,949	0,920	0,892	0,866	0,842	0,819	0,797	0,756	0,702	0,628	0,568	0,519	0,477	0,442
	2000	1,196	1,101	1,020	0,984	0,967	0,951	0,919	0,890	0,862	0,837	0,812	0,789	0,767	0,747	0,709	0,659	0,589	0,533	0,486	0,447	0,414
2500	1,116	1,028	0,952	0,919	0,903	0,887	0,858	0,831	0,805	0,781	0,758	0,737	0,716	0,697	0,662	0,615	0,550	0,497	0,454	0,417	0,386	

## PRINCIPES GENERAUX DES VENTILATEURS

### 1) PARAMETRES

Les principaux paramètres qui identifient un ventilateur sont au nombre de quatre :

Débit (V)                      Pression (p)                      Rendement (%)                      Vitesse de rotation (n° min.<sup>-1</sup>)

#### 1.1) Débit :

Le débit est la quantité de fluide mise en mouvement par le ventilateur, en terme de volume dans l'unité de temps, et s'exprime généralement en m<sup>3</sup>/h, m<sup>3</sup>/min, m<sup>3</sup>/s.

#### 1.2) Pression :

La pression totale (pt) est la somme de la pression statique (pst), c'est-à-dire l'énergie nécessaire pour vaincre les frottements dus à l'installation, et de la pression dynamique (pd) ou énergie cinétique imprimée au fluide en mouvement (pt = pst + pd).

La pression dynamique dépend de la vitesse (v) et du poids spécifique du fluide (y).

$$pd = \frac{1}{2} \cdot y \cdot v^2 \quad \text{Où :} \quad \begin{array}{l} pd = \text{pression dynamique} \quad (\text{Pa}) \\ y = \text{poids spécifique du fluide} \quad (\text{kg/m}^3) \\ v = \text{vitesse du fluide à la bouche du ventilateur, souhaitée dans l'installation} \quad (\text{m/s}) \end{array}$$

$$v = \frac{V}{A} \quad \text{Où :} \quad \begin{array}{l} V = \text{débit} \quad (\text{m}^3/\text{s}) \\ A = \text{section de la bouche, souhaitée dans l'installation} \quad (\text{m}^2) \\ v = \text{vitesse du fluide à la bouche du ventilateur, souhaitée dans l'installation} \quad (\text{m/s}) \end{array}$$

#### 1.3) Rendement :

Le rendement est le rapport entre l'énergie restituée par le ventilateur et l'énergie absorbée par le moteur actionnant le ventilateur.

$$\eta = \frac{V \cdot pt}{1,02 \cdot P} \quad \text{Où :} \quad \begin{array}{l} \eta = \text{rendement} = (\%) \\ V \text{ débit} \quad (\text{m}^3/\text{s}) \\ P = \text{puissance absorbée} \quad (\text{kW}) \\ pt = \text{pression totale} \quad (\text{daPa}) \end{array}$$

#### 1.4) Vitesse de rotation :

La vitesse de rotation est le nombre de tours que la roue du ventilateur doit accomplir pour fournir les caractéristiques requises.

En faisant varier le nombre de tours (n) et en maintenant constant le poids spécifique du fluide (y), on obtient les variations suivantes :

Le débit (V) est directement proportionnel à la vitesse de rotation, donc :

$$V_1 = V \cdot \frac{n_1}{n} \quad \text{Où :} \quad \begin{array}{l} n = \text{vitesse de rotation} \\ V = \text{débit} \\ V_1 = \text{nouveau débit obtenu par variation de la vitesse de rotation} \\ n_1 = \text{nouvelle vitesse de rotation} \end{array}$$

La pression totale (pt) varie comme le carré du rapport des vitesses de rotation, donc :

$$pt_1 = pt \cdot \left(\frac{n_1}{n}\right)^2 \quad \text{Où :} \quad \begin{array}{l} n = \text{vitesse de rotation} \\ pt = \text{pression totale} \\ pt_1 = \text{nouvelle pression totale obtenue par variation de la vitesse de rot.} \\ n_1 = \text{nouvelle vitesse de rotation} \end{array}$$

La puissance absorbée (P) varie comme le cube du rapport des vitesses de rotation, donc :

$$P_1 = P \cdot \left(\frac{n_1}{n}\right)^3 \quad \text{Où :} \quad \begin{array}{l} n = \text{vitesse de rotation} \\ P = \text{puissance absorbée} \\ P_1 = \text{nouvelle puissance absorbée obtenue par variation de la vitesse de rot.} \\ n_1 = \text{nouvelle vitesse de rotation} \end{array}$$

## 2) DIMENSIONNEMENT

Les caractéristiques, que nous reportons dans les tableaux suivants, se réfèrent à un fonctionnement avec un fluide (l'air) à la température de + 15°C et sous une pression barométrique de 760 mm Hg (poids spécifique = 1.226 kg/m<sup>3</sup>).

Les données relatives au bruit se réfèrent à une mesure en champ libre, à la distance de 1,5 m, lorsque le ventilateur fonctionne au débit maximal.

Les valeurs reportées sont sujettes aux tolérances suivantes : débit ± 5% - bruit +3 dB(A).

Lorsque les conditions du fluide véhiculé diffèrent de celles indiquées ci-dessus, il faut tenir compte de la température et de la pression barométrique qui influent directement sur le poids spécifique du fluide.

Lorsque le poids spécifique varie, le débit (V) reste constant en volume, la pression (pt) et la puissance (P) varient directement avec le rapport des poids spécifiques.

$$pt_1 = \frac{y_1}{y} \cdot pt \quad \left| \quad P_1 = \frac{y_1}{y} \cdot P \quad \text{Où :} \quad \begin{array}{l} pt = \text{pression totale} \\ P = \text{puissance absorbée} \\ y = \text{poids spécifique du fluide} \\ y_1 = \text{nouveau poids spécifique du fluide} \\ pt_1 = \text{nouvelle pression totale obtenue par variation du poids spécifique} \\ P_1 = \text{nouvelle puissance absorbée obtenue par variation du poids spéc.} \end{array}$$

Le poids spécifique (y) se calcule à l'aide de la formule suivante :

$$y = \frac{Pb \cdot 13,59}{29,27 \cdot (273+t)} \quad \text{Où :} \quad \begin{array}{l} y = \text{poids spécifique de l'air à } t \text{ °C} \quad (\text{kg/m}^3) \\ Pb = \text{pression barométrique} \quad (\text{mm Hg}) \\ t = \text{température du fluide (°C)} \quad 13,59 = \text{poids spécifique du mercure à } 0 \text{ °C} \quad (\text{kg/dm}^3) \end{array}$$

Pour faciliter le calcul, le poids de l'air, sous différentes altitudes et différentes températures, est reporté ci-dessous :

		Température																				
		-40°C	-20°C	0°C	10°C	15°C	20°C	30°C	40°C	50°C	60°C	70°C	80°C	90°C	100°C	120°C	150°C	200°C	250°C	300°C	350°C	400°C
Altitude en mètres au-dessus du niveau de la mer	0	1,514	1,395	1,293	1,247	1,226	1,204	1,165	1,127	1,092	1,060	1,029	1,000	0,972	0,946	0,898	0,834	0,746	0,675	0,616	0,566	0,524
	500	1,435	1,321	1,225	1,181	1,161	1,141	1,103	1,068	1,035	1,004	0,975	0,947	0,921	0,896	0,851	0,790	0,707	0,639	0,583	0,537	0,497
	1000	1,355	1,248	1,156	1,116	1,096	1,078	1,042	1,009	0,977	0,948	0,920	0,894	0,870	0,846	0,803	0,746	0,667	0,604	0,551	0,507	0,469
	1500	1,275	1,175	1,088	1,050	1,032	1,014	0,981	0,949	0,920	0,892	0,866	0,842	0,819	0,797	0,756	0,702	0,628	0,568	0,519	0,477	0,442
	2000	1,196	1,101	1,020	0,984	0,967	0,951	0,919	0,890	0,862	0,837	0,812	0,789	0,767	0,747	0,709	0,659	0,589	0,533	0,486	0,447	0,414
	2500	1,116	1,028	0,952	0,919	0,903	0,887	0,858	0,831	0,805	0,781	0,758	0,737	0,716	0,697	0,662	0,615	0,550	0,497	0,454	0,417	0,386

## ALLGEMEINE ANGABEN ÜBER DIE VENTILATOREN

### 1) PARAMETER

Die hauptsächlichen Parameter, die einen Ventilator auszeichnen, sind vier :

Fördermenge (V)                      Druck (p)                      Leistung (%)                      Drehgeschwindigkeit (n° min.<sup>-1</sup>)

#### 1.1) Fördermenge:

Die Fördermenge ist das Volumen der Masse des vom Ventilator bewegten Fluids in der Zeiteinheit und wird normalerweise ausgedrückt in m<sup>3</sup>/h, m<sup>3</sup>/min., m<sup>3</sup>/sec.

#### 1.2) Druck:

Der Gesamtdruck (pt) ist die Summe zwischen dem statischen Druck und der für die Überwindung der von der Anlage entgegengesetzten Reibungen erforderlichen Energie und dem dynamischen Druck (pd) oder der kinetischen Energie, die dem in Bewegung befindlichen Fluid eingeprägt ist (pt = pst + pd).

Der dynamische Druck hängt von der Geschwindigkeit (v) und vom spezifischen Gewicht des Fluids (y) ab.

$$pd = \frac{1}{2} \cdot y \cdot v^2$$

Wo:      pd = dynamischer Druck (Pa)  
           y = spezifisches Gewicht des Fluids (Kg/m<sup>3</sup>)  
           v = Geschwindigkeit des Fluids an der Düse des von der Anlage interessierten Ventilators (m/sec)

$$v = \frac{V}{A}$$

Wo:      V = Fördermenge (m<sup>3</sup>/sec)  
           A = Schnitt der von der Anlage interessierten Düse (m<sup>2</sup>)  
           v = Geschwindigkeit des Fluids an der Düse des von der Anlage interessierten Ventilators (m/sec)

#### 1.3) Leistung:

Die Leistung ist das Verhältnis zwischen der vom Ventilator abgegebenen Energie und der vom Motor, der den Ventilator antreibt, aufgenommenen.

$$\eta = \frac{V \cdot pt}{1,02 \cdot P}$$

Wo:      η = Leistung (%)                      P = aufgen.Kraft (kW)  
           V = Fördermenge (m<sup>3</sup>/sec)                      pt = Gesamtdruck (daPa)

#### 1.4) Drehgeschwindigkeit:

Die Drehgeschwindigkeit ist die Anzahl der Umdrehungen, die das Laufrad des Ventilators ausführen muß, um die verlangten Eigenschaften zu erfüllen.

Bei Veränderung der Umdrehungszahl (n) und bei konstanter Beibehaltung des spezifischen Gewichts des Fluids (y), werden folgende Variationen erreicht :

Die Fördermenge (V) ist direkt proportionell zur Drehgeschwindigkeit, also :

$$V_1 = V \cdot \frac{n_1}{n}$$

Wo:      n = Drehgeschwind.      V<sub>1</sub> = neue F.Menge, erreicht b.Variat.d.Drehgeschwindigk.  
           V = Fördermenge                      n<sub>1</sub> = neue Drehgeschwindigkeit

Der Gesamtdruck (pt) variiert mit der Quadratzahl des Verhältnisses der Drehgeschwindigkeiten, also:

$$pt_1 = pt \cdot \left(\frac{n_1}{n}\right)^2$$

Wo:      n = Drehgeschw.      pt<sub>1</sub> = neuer Ges.Druck, erreicht b.Variat.d.Drehgeschw.  
           pt = Gesamtdruck                      n<sub>1</sub> = neue Drehgeschwindigkeit

Die aufgenommene Kraft (P) variiert mit der Kubikzahl des Verhältnisses der Drehgeschwindigkeiten, also:

$$P_1 = P \cdot \left(\frac{n_1}{n}\right)^3$$

Wo:      n = Drehgeschwind.      P<sub>1</sub> = neue aufgen.Kraft, erreicht b.Variat.d.Drehgeschw.  
           P = aufgen. Kraft                      n<sub>1</sub> = neue Drehgeschwindigkeit

## 2) BEMESSUNG

Die von uns in den folgenden Tabellen ausgedrückten Eigenschaften beziehen sich auf den Betrieb mit Fluid (Luft) bei Temperatur von + 15° und barometrischem Druck von 760 mm Hg (spezifisches Gewicht = 1.226 kg/m<sup>3</sup>).

Die das Geräusch betreffenden Daten beziehen sich auf eine Messung auf freiem Feld in einer Entfernung von 1,5 m und Ventilator, funktionierend mit Höchstleistungskraft.

Die angegebenen Werte unterliegen den folgenden Toleranzen : Fördermenge ± 5% - Geräusch +3 dB(A).

Wenn die Bedingungen des bewegten Fluids sich von den o.a. unterscheiden ist zu beachten, daß Temperatur und barometrischer Druck direkt auf das spezifische Gewicht des Fluids einwirken.

Bei Variation des spezifischen Gewichts bleibt die Fördermenge (V) in bezug auf das Volumen konstant, während der Druck (pt) und die Kraft (P) direkt mit dem Verhältnis der spezifischen Gewichte variieren.

$$pt_1 = \frac{y_1}{y} \cdot pt \quad \left| \quad P_1 = \frac{y_1}{y} \cdot P$$

Wo:      pt = Gesamtdruck                      pt<sub>1</sub> = neuer Gesamtdruck, erreicht b.Variat. d. spez.Gew.  
           P = aufgen. Kraft                      P<sub>1</sub> = neue aufgen.Kraft, erreicht b.Variat. d. spez.Gew.  
           y = spez.Gew. Fluid                      y<sub>1</sub> = spezifisches Gewicht des Fluids

Das spezifische Gewicht (y) kann mit der folgenden Formel berechnet werden :

$$y = \frac{Pb \cdot 13,59}{29,27 \cdot (273+t)}$$

Wo:      y = spez.Gew. d.Luft b. temp. °C (Kg/m<sup>3</sup>)  
           Pb = barometrischer Druck (mm Hg)  
           t = Temperatur d. Fluids (°C)                      13,59 = spez.Gew.d. Quecksilbers b.0°C (kg/dm<sup>3</sup>)

Zur Erleichterung der Berechnung geben wir das Gewicht der Luft bei den verschiedenen Temperaturen und Höhen an:

		Temperatur																				
		-40°C	-20°C	0°C	10°C	15°C	20°C	30°C	40°C	50°C	60°C	70°C	80°C	90°C	100°C	120°C	150°C	200°C	250°C	300°C	350°C	400°C
Höhe i.d.M.	0	1,514	1,395	1,293	1,247	1,226	1,204	1,165	1,127	1,092	1,060	1,029	1,000	0,972	0,946	0,898	0,834	0,746	0,675	0,616	0,566	0,524
	500	1,435	1,321	1,225	1,181	1,161	1,141	1,103	1,068	1,035	1,004	0,975	0,947	0,921	0,896	0,851	0,790	0,707	0,639	0,583	0,537	0,497
	1000	1,355	1,248	1,156	1,116	1,096	1,078	1,042	1,009	0,977	0,948	0,920	0,894	0,870	0,846	0,803	0,746	0,667	0,604	0,551	0,507	0,469
	1500	1,275	1,175	1,088	1,050	1,032	1,014	0,981	0,949	0,920	0,892	0,866	0,842	0,819	0,797	0,756	0,702	0,628	0,568	0,519	0,477	0,442
	2000	1,196	1,101	1,020	0,984	0,967	0,951	0,919	0,890	0,862	0,837	0,812	0,789	0,767	0,747	0,709	0,659	0,589	0,533	0,486	0,447	0,414
2500	1,116	1,028	0,952	0,919	0,903	0,887	0,858	0,831	0,805	0,781	0,758	0,737	0,716	0,697	0,662	0,615	0,550	0,497	0,454	0,417	0,386	

### CARATTERISTICHE TECNICHE

Serie di ventilatori ad accoppiamento diretto con portate tra 33 e 850 m<sup>3</sup>/min e pressioni tra 10 a 400 daPa, ideati per il trasporto di fumi e polveri, in miscela con l'aria fino alla temperatura massima di +80°C.

Per temperature fino a +170°C la serie SFRK viene dotata di coclea saldata, motore con albero prolungato, distanziale, ventolina di raffreddamento e verniciatura alluminio alta temperatura.

La serie SCRK non può essere utilizzata per il trasporto di aria con elevate concentrazioni di umidità tali da rendere necessario il manicotto di scarico condensa. Per questa applicazione consigliamo la serie SFRK con manicotto di scarico e coclea saldata.

### COSTRUZIONE

Coclea in acciaio zincato a giunzione graffata di forte spessore, in esecuzione cubica. Girante a pale rovesce, in alluminio a profilo alare (SCRK), in acciaio saldato a profilo costante (SFRK). Motore in forma B5 50 Hz 230/400 V per potenze fino a 4 kW e 400/690 V per potenze superiori.

### TECHNICAL FEATURES

Set of direct-coupling fans with volume from 33 to 850 m<sup>3</sup>/min and pressure from 10 to 400 daPa, suitable for conveyance of fumes and dust, mixed with air, having +80° C max. temperature. For temperature values up to +170°C, the fans series SFRK are equipped with welded fan casing, motor with extended shaft, spacer, cooling fan, and they are varnished with Aluminium-paint suitable for high temperature. The series SCRK cannot be used for conveyance of air with high moisture concentration, which require the use of a condensate-draining sleeve. For this application we recommend the serie SFRK with drain sleeve and welded fan casing.

### CONSTRUCTION FEATURES

Galvanized steel fan casing with high-thickness clinched junction, cube-shaped. Backward blades impeller made of wing-contour Aluminium (SCRK), or steady-profile welded steel (SFRK).

Motor Form B5, 50 Hz, 230/400 V for power up to 4 kW and 400/690 V for higher ratings.

### CARACTERISTIQUES TECHNIQUES

Série de ventilateurs à accouplement direct avec débit compris entre 33 et 850 m<sup>3</sup>/min et pression entre 10 et 400 daPa, adaptés au transport des fumées et des poussières mélangées à l'air, jusqu'à une température maximale de +80°C. Pour des températures atteignant +170°C, la série SFRK est équipée d'une virole soudée, d'un moteur comportant un arbre prolongé, d'une entretoise, d'un ventilateur de refroidissement et d'une peinture aluminium à haute température. La série SCRK ne peuvent pas être utilisée pour le transport d'air à haute concentration d'humidité nécessitant un manchon de décharge de la condensation. Nous vous conseillons, pour cette application, la série SFRK avec manchon de décharge et virole soudée.

### CONSTRUCTION







Virole en acier zingué à jonction accolée de forte épaisseur, en exécution cubique.. Roue à aubes renversées, en aluminium à profil alaire (SCRK), en acier soudé à profil constant (SFRK). Moteur en forme B5, 50 Hz, 230/400 V pour des puissances jusqu'à 4 kW et 400/690 V pour les puissances supérieures.

### TECHNISCHE MERKMALE

Serie Ventilatoren mit direkter Kupplung für mittlere Drücke (Fördermenge zwischen 33 und 850 m<sup>3</sup>/min und Drücke zwischen 10 und 400 daPa), geeignet zum Transport von Rauch und Staub gemischt mit Luft bis zu einer Höchsttemperatur von +80°C. Für Temperaturen bis zu +170°C werden die Serien SFRK mit einer geschweißten Förderschnecke, einem Motor mit verlängerter Welle, Abstandstück, Kühlrad und hochtemperaturbeständiger Alulackierung versehen. Die Serien SCRK können nicht für den Transport von Luft mit hohen Feuchtigkeitskonzentrationen angewendet werden, die den Einsatz einer Kondenswasserablaßmuffe verlangen. Für diese Anwendung empfehlen wir die Serie SFRK mit Abblaßmuffe und geschweißter Förderschnecke.

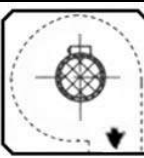
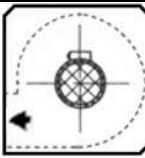
### BAUAUSFUHRUNG

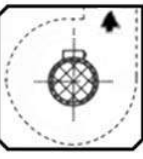
Förderschnecke aus verzinktem Stahl mit starkbemessener Verklammerung, in kubischer Ausführung. Laufrad mit Kipflügeln, aus Aluminium mit Flügelprofil (SCRK), aus geschweißtem Stahl mit konstantem Profil (SFRK). Motor in der Form B5 50 Hz 230/400 V für Leistungen bis zu 4 kW und 400/690 V für höhere Leistungen.

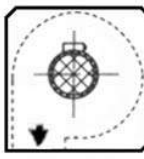
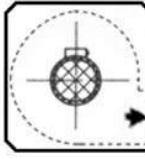
SCRK / SFRK				
 <b>RD</b>	 <b>RD 0</b>	 <b>RD 90</b>	 <b>RD 180</b>	 <b>RD 270</b>
 <b>LG</b>	 <b>LG 0</b>	 <b>LG 90</b>	 <b>LG 180</b>	 <b>LG 270</b>

ORIENTAMENTI NORME EUROVENT (VISTE LATO MOTORE)  
 ORIENTATIONS NORMES EUROVENT (VUE CÔTÉ MOTEUR)

EUROVENT RULES ORIENTATIONS (MOTOR SIDE)  
 GEHÄUSES TELLUNGEN NACH EUROVENT-NORM VON ANTRIEBSSEITE GESEHEN



- Dimensioni d'ingombro e pesi.
- Overall dimensions and weights.
- Dimensions d'encombrement et poids.
- Abmessungen und Gewichte.

## SCRK - SFRK

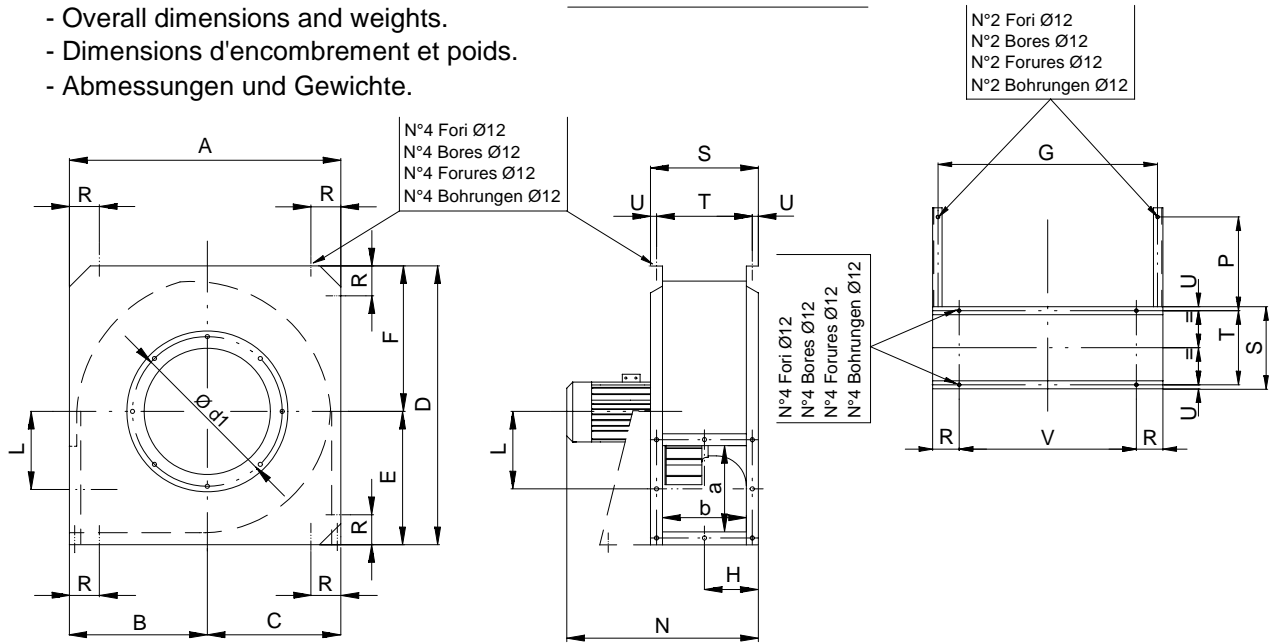

### SCRK - SFRK

TIPO-TYPE-TYPE-TYP VENTILATORE FAN VENTILATEUR VENTILATOR	Motore Motor Moteur Motor	Ventilatore Fan Ventilateur Ventilator											Basamento Base Chassis Sockel							Peso Weight Poids Gewicht (*)					
		A	B	C	D	Ød1	E	F	H	L	N	a	b	Rot. 90° G	Rot. 0° 180°	P	R	S	T		U	Rot. 90° V	Rot. 0° 180°		
SCRK - SFRK 40/A	132 M2										713			705	765	315									127
SCRK - SFRK 40/B	80 M4	735	300	435	795	450	460	335	180	230	565	400	300	--	--	--	100	360	330	15	535	595			74
SCRK - SFRK 40/C	90 M6										565														73
SCRK - SFRK 45/A	132 M2										890			720	820	315									165
SCRK - SFRK 45/B	90 M4	750	330	420	850	500	490	360	205	247	635	430	350	--	--	--	100	410	380	15	550	650			115
SCRK - SFRK 45/C	80 M6										595														84
SCRK - SFRK 50/A	160 M2										940			780	900	315									207
SCRK - SFRK 50/B	100 L4	810	350	460	930	550	540	390	230	273	745	475	400	--	--	--	100	460	430	15	610	730			112
SCRK - SFRK 50/C	90 M6										690														100
SCRK - SFRK 55/A	180 M2										1075			910	990	310									278
SCRK - SFRK 55/B	100 L4	950	450	500	1030	610	610	420	260	305	800	520	440	--	--	--	100	520	480	20	750	830			135
SCRK - SFRK 55/C	100 L6										800														135
SCRK - SFRK 55/D	112 M8										800														135
SCRK - SFRK 60/A	112 M4										850														155
SCRK - SFRK 60/B	100 M6	1020	472	548	1120	660	662	458	280	333	840	580	480	--	--	--	100	560	520	20	820	920			150
SCRK - SFRK 60/C	112 M8										840														150
SCRK - SFRK 65/A	132 S4										990														205
SCRK - SFRK 65/B	112 M6	1090	498	592	1210	710	712	498	300	358	850	630	520	--	--	--	100	600	560	20	890	1010			175
SCRK - SFRK 65/C	112 M8										850														175
SCRK - SFRK 70/A	132 M4										1020			1130	1260	310									260
SCRK - SFRK 70/B	132 S6	1170	532	638	1300	760	762	538	320	383	1020	680	560	--	--	--	100	640	600	20	970	1100			220
SCRK - SFRK 70/C	132 M8										1020														215
SCRK - SFRK 75/A	160 M4										1150			1200	1330	310									300
SCRK - SFRK 75/B	132 M6	1240	558	682	1390	810	812	578	340	408	1060	730	600	--	--	--	100	680	640	20	1040	1190			250
SCRK - SFRK 75/C	132 M8										1060														250
SCRK - SFRK 80/A	160 L4										1250			1420	1525	305									335
SCRK - SFRK 80/B	132 M6	1425	645	825	1575	860	898	677	370	458	1110	800	640	--	--	--	100	740	690	25	1375	1470			275
SCRK - SFRK 80/C	160 M8										1200														290
SCRK - SFRK 90/A	200 L4										1470			1600	1715	305									515
SCRK - SFRK 90/B	160 L6	1650	725	925	1765	960	1005	760	410	515	1324	900	720	--	--	--	100	820	770	25	1450	1565			375
SCRK - SFRK 90/C	160 M8										1280														340
SCRK-SFRK 100/A	280 M4										1615			1780	1910	305									655
SCRK-SFRK 100/B	180 M6	1830	805	1025	1960	1060	1120	840	470	572	1465	1000	800	--	--	--	100	940	870	25	1630	1760			490
SCRK-SFRK 100/C	200/L4										1424														430

Tabella non impegnativa - The above data are unbinding - Tableau sans engagement - Mabe unverbindlich.

\* Peso ventilatore in Kg. (completo di motore) - Fan weight in Kg.(including motor)  
Poids du ventilateur en Kg.(complet avec moteur) - Ventilator Gewicht in Kg.(mit Motor).

Per foratura flange aspiranti-prementi vedere accessori pag.15. - For drilling of the inlet/outlet flanges, please refer to Accessories on page 15.

Pour la forure des brides à l'aspiration et au roulement, voir les accessoires en page 15.- Für die Bohrung der druckseitigen/saugseitigen Flansche siehe Zubehör Seite 15.

Tipo Type Type Typ	n° Min. <sup>-1</sup> rpm	Lp dB(A)	Motore Motor Moteur Motor	kW inst.	CARATTERISTICHE - SPECIFICATIONS - CARACTERISTIQUES - EIGENSCHAFTEN SCRK (3000 rpm)																									
					V= m <sup>3</sup> /min																									
SCRK					41	50	58	66	75	83	100	116	133	166	208	250	291	333	416	500	583	666	750	833	916	1000	1166			
40/A	2840	75	132SA2	5,5	Pst.				223	212	192	169	138	101	21															
					Pt.				<b>228</b>	<b>218</b>	<b>199</b>	<b>180</b>	<b>152</b>	<b>120</b>	<b>50</b>															
45/A	2840	76	132MB2	9,2	Pst.						330	308	281	247	175	44														
					Pt.						<b>335</b>	<b>315</b>	<b>291</b>	<b>260</b>	<b>195</b>	<b>75</b>														
50/A	2865	78	160M2	15	Pst.								378	354	300	226	148	59												
					Pt.									<b>384</b>	<b>363</b>	<b>313</b>	<b>247</b>	<b>178</b>	<b>100</b>											
55/A	2920	80	180M2	22	Pst.									411	382	341	283	222	151											
					Pt.											<b>417</b>	<b>391</b>	<b>355</b>	<b>304</b>	<b>250</b>	<b>188</b>									

Pst (daPa) = pressione statica - static pressure  
 pression statique - statischer Druck  
 Pt (daPa) = pressione totale - total pressure  
 pression totale - Gesamtdruck

Tipo Type Type Typ	n° Min. <sup>-1</sup> rpm	Lp dB(A)	Motore Motor Moteur Motor	kW inst.	CARATTERISTICHE - SPECIFICATIONS - CARACTERISTIQUES - EIGENSCHAFTEN SCRK (1500 rpm)																									
					V= m <sup>3</sup> /min																									
SCRK					41	50	58	66	75	83	100	116	133	166	208	250	291	333	416	500	583	666	750	833	916	1000	1166			
40/B	1380	61	80B4	0,75	Pst.	51	40	33	25	13	4																			
					Pt.	<b>53</b>	<b>43</b>	<b>37</b>	<b>30</b>	<b>19</b>	<b>11</b>																			
45/B	1410	62	90S4	1,1	Pst.		84	74	65	55	46	23																		
					Pt.		<b>86</b>	<b>76</b>	<b>68</b>	<b>59</b>	<b>51</b>	<b>30</b>																		
50/B	1425	63	100LA4	2,2	Pst.			93	89	82	77	69	45	29																
					Pt.			<b>95</b>	<b>91</b>	<b>85</b>	<b>80</b>	<b>74</b>	<b>51</b>	<b>38</b>																
55/B	1430	64	100LB4	3	Pst.				99	97	95	87	76	64	31	6														
					Pt.				<b>100</b>	<b>99</b>	<b>97</b>	<b>90</b>	<b>80</b>	<b>70</b>	<b>40</b>	<b>20</b>														
60/A	1430	70	112M4	4	Pst.						118	113	107	101	84	70	36													
					Pt.							<b>120</b>	<b>115</b>	<b>110</b>	<b>105</b>	<b>90</b>	<b>80</b>	<b>50</b>												
65/A	1440	73	132SA4	5,5	Pst.								158	147	136	113	90	56	12											
					Pt.										<b>160</b>	<b>150</b>	<b>140</b>	<b>120</b>	<b>100</b>	<b>70</b>	<b>30</b>									
70/A	1440	75	132M4	9,2	Pst.									177	165	153	140	107	49											
					Pt.											<b>180</b>	<b>170</b>	<b>160</b>	<b>150</b>	<b>120</b>	<b>70</b>									
75/A	1440	77	160M4	11	Pst.											214	197	160	104	21										
					Pt.														<b>220</b>	<b>205</b>	<b>170</b>	<b>120</b>	<b>44</b>							
80/A	1455	81	160L4	15	Pst.												234	198	169	133	77	11								
					Pt.															<b>240</b>	<b>205</b>	<b>180</b>	<b>150</b>	<b>100</b>	<b>40</b>					
90/A	1465	83	200L4	30	Pst.														273	250	226	182	147	101	45					
					Pt.																	<b>280</b>	<b>260</b>	<b>240</b>	<b>200</b>	<b>170</b>	<b>130</b>	<b>80</b>		
100/A	1440	87	225M4	45	Pst.															323	311	298	265	241	217	173	83			
					Pt.																		<b>330</b>	<b>320</b>	<b>310</b>	<b>280</b>	<b>260</b>	<b>240</b>	<b>200</b>	<b>120</b>

Pst (daPa) = pressione statica - static pressure  
 pression statique - statischer Druck  
 Pt (daPa) = pressione totale - total pressure  
 pression totale - Gesamtdruck

Tolleranza: sulla portata  $\pm 5\%$ , sulla rumorosità +3dB(A) - Tolerance: capacity  $\pm 5\%$ , noise +3dB(A) - Tolérance: débit  $\pm 5\%$ , bruit +3dB(A) - Toleranz: Fördermenge  $\pm 5\%$ , Geräusch +3dB(A)

Le caratteristiche riportate sono riferite al funzionamento con aria a +15°C alla pressione barometrica di 760 mmHg. Peso specifico 1,226 kg/m<sup>3</sup> (caratteristiche in mandata)

The tables show the characteristics of an operating device at air +15°C, barometric pressure 760 mmHg, specific gravity 1,226 kg/m<sup>3</sup> (specifications in discharge stage)

Les caractéristiques mentionnées sont rapportées au fonctionnement avec air +15°C à la pression barométrique de 760 mmHg, poids spécifique 1,226 kg/m<sup>3</sup> (caractéristiques en soufflage)

Die in der Tabelle angezeigten Daten beziehen sich auf Luft bei einer Temperatur von +15°C, barometrischem Druck 760 mmHg und auf ein spezifisches Gewicht der Luft von 1,226 kg/m<sup>3</sup> (eigenschaften druckseitig)

Tipo Type Type Typ SCRK	n° Min. <sup>-1</sup> rpm	Lp dB(A)	Motore Motor Moteur Motor	kW Inst.	CARATTERISTICHE - SPECIFICATIONS - CARACTERISTIQUES - EIGENSCHAFTEN SCRK (1000 rpm)																							
					V= m <sup>3</sup> /min																							
					33	41	50	58	66	75	83	100	116	133	166	208	250	291	333	416	500	583	666	750	833	916	1000	
40/C	960	52	80B6	0,55	Pst.	23	15	8	2																			
					Pt.	24	17	11	6																			
45/C	960	53	80B6	0,55	Pst.		36	30	24	19	9																	
					Pt.		37	32	26	22	13																	
50/C	960	54	90S6	0,75	Pst.			42	36	33	27	22	15	4														
					Pt.			43	38	35	30	25	20	10														
55/C	960	55	100LA6	1,5	Pst.				44	41	38	35	29	21	11													
					Pt.				45	42	40	37	32	25	17													
60/B	960	61	100LA6	1,5	Pst.					51	50	48	47	42	35	26	4											
					Pt.					52	51	50	49	45	39	32	14											
65/B	960	64	112M6	2,2	Pst.						69	68	63	58	49	36												
					Pt.						70	69	65	60	52	40												
70/B	960	66	132SA6	3	Pst.									78	77	73	64	49	29	5								
					Pt.													80	79	76	69	56	39	18				
75/B	960	68	132MA6	4	Pst.											90	86	74	62	30	4							
					Pt.														92	90	80	70	40	20				
80/B	960	73	132MB6	5,5	Pst.												97	94	84	73	54	13						
					Pt.															100	98	90	80	65	30			
90/B	960	75	160L6	11	Pst.															135	118	90	61	32				
					Pt.																		140	125	100	75	50	
100/B	960	78	180L6	15	Pst.																	155	143	121	98	70	41	9
					Pt.																				160	150	130	110

Pst (daPa) = pressione statica - static pressure  
 pression statique - statischer Druck  
 Pt (daPa) = pressione totale - total pressure  
 pression totale - Gesamtdruck

Tipo Type Type Typ SCRK	n° Min. <sup>-1</sup> rpm	Lp dB(A)	Motore Motor Moteur Motor	kW Inst.	CARATTERISTICHE - SPECIFICATIONS - CARACTERISTIQUES - EIGENSCHAFTEN SCRK (750 rpm)																				
					V= m <sup>3</sup> /min																				
					33	41	50	58	66	75	83	100	116	133	166	208	250	291	333	416	500	583	666	750	833
55/D	710	49	100LB8	1,1	Pst.	24	22	20	17	15	11	6													
					Pt.	24	23	21	18	16	13	8													
60/C	710	55	100LB8	1,1	Pst.		28	26	25	24	22	19	14	6											
					Pt.		28	27	26	25	23	21	16	9											
65/C	710	58	112M8	1,5	Pst.				35	34	33	31	25	20	15	1									
					Pt.				36	35	34	32	27	22	18	5									
70/C	710	60	132S8	2,2	Pst.						45	44	43	38	36	26	15								
					Pt.						46	45	44	40	38	29	20								
75/C	710	62	132M8	3	Pst.									51	47	38	28	9	2						
					Pt.													52	49	40	32	15	10		
80/C	710	66	160MA8	4	Pst.										57	49	46	34	21	3					
					Pt.													58	51	49	38	27	10		
90/C	710	68	160MB8	5,5	Pst.											71	65	56	45	23	1				
					Pt.													73	68	60	50	30	11		
100/C	710	72	160L8	7,5	Pst.												88	81	75	60	42	21	1		
					Pt.															90	83	78	65	49	30

Pst (daPa) = pressione statica - static pressure  
 pression statique - statischer Druck  
 Pt (daPa) = pressione totale - total pressure  
 pression totale - Gesamtdruck

Tolleranza: sulla portata  $\pm 5\%$ , sulla rumorosità  $+3dB(A)$  - Tolerance: capacity  $\pm 5\%$ , noise  $+3dB(A)$  - Tolérance: débit  $\pm 5\%$ , bruit  $+3dB(A)$  - Toleranz: Fördermenge  $\pm 5\%$ , Geräusch  $+3dB(A)$

Le caratteristiche riportate sono riferite al funzionamento con aria a  $+15^\circ C$  alla pressione barometrica di 760 mmHg. Peso specifico 1,226 kg/r<sup>3</sup> (caratteristiche in mandata)  
 The tables show the characteristics of an operating device at air  $+15^\circ C$ , barometric pressure 760 mmHg, specific gravity 1,226 kg/m<sup>3</sup> (specifications in discharge stage)  
 Les caractéristiques mentionnées sont rapportées au fonctionnement avec air  $+15^\circ C$  à la pression barométrique de 760 mmHg, poids spécifique 1,226 kg/m<sup>3</sup> (caractéristiques en soufflage)  
 Die in der Tabelle angezeigten Daten beziehen sich auf Luft bei einer Temperatur von  $+15^\circ C$ , barometrischem Druck 760 mmHg und auf ein spezifisches Gewicht der Luft von 1,226 kg/m<sup>3</sup> (eigenschaften druckseitig)

Tipo Type Type Typ	n° Min. <sup>-1</sup> rpm	Lp dB(A)	Motore Motor Moteur Motor	kW inst.	CARATTERISTICHE - SPECIFICATIONS - CARACTERISTIQUES - EIGENSCHAFTEN SFRK (3000 rpm)																								
					V= m <sup>3</sup> /min																								
SFRK					41	50	58	66	75	83	100	116	133	166	208	250	291	333	416	500	583	666	750	833	916	1000	1166		
40/A	2840	75	132SA2	5,5	Pst.				217	205	186	164	133	98	19														
					Pt.				<b>221</b>	<b>211</b>	<b>193</b>	<b>175</b>	<b>147</b>	<b>116</b>	<b>49</b>														
45/A	2840	76	132MB2	9,2	Pst.						320	298	273	239	169	41													
					Pt.						<b>325</b>	<b>306</b>	<b>282</b>	<b>252</b>	<b>189</b>	<b>73</b>													
50/A	2865	78	160M2	15	Pst.								366	344	290	219	143	56											
					Pt.										<b>372</b>	<b>352</b>	<b>304</b>	<b>240</b>	<b>173</b>	<b>97</b>									
55/A	2920	80	180M2	22	Pst.										399	370	330	274	214	146									
					Pt.											<b>404</b>	<b>379</b>	<b>344</b>	<b>295</b>	<b>243</b>	<b>182</b>								

Pst (daPa) = pressione statica - static pressure  
 pression statique - statischer Druck  
 Pt (daPa) = pressione totale - total pressure  
 pression totale - Gesamtdruck

Tipo Type Type Typ	n° Min. <sup>-1</sup> rpm	Lp dB(A)	Motore Motor Moteur Motor	kW inst.	CARATTERISTICHE - SPECIFICATIONS - CARACTERISTIQUES - EIGENSCHAFTEN SFRK(1500 rpm)																									
					V= m <sup>3</sup> /min																									
SFRK					41	50	58	66	75	83	100	116	133	166	208	250	291	333	416	500	583	666	750	833	916	1000	1166			
40/B	1380	61	80B4	0,75	Pst.	50	39	32	24	12	3																			
					Pt.	<b>51</b>	<b>42</b>	<b>36</b>	<b>29</b>	<b>18</b>	<b>11</b>																			
45/B	1410	62	90S4	1,1	Pst.		82	71	63	53	44	22																		
					Pt.		<b>83</b>	<b>74</b>	<b>66</b>	<b>57</b>	<b>49</b>	<b>29</b>																		
50/B	1425	63	100LA4	2,2	Pst.			91	86	80	74	67	43	28																
					Pt.			<b>92</b>	<b>88</b>	<b>82</b>	<b>78</b>	<b>72</b>	<b>49</b>	<b>37</b>																
55/B	1430	64	100LB4	3	Pst.				96	94	92	84	73	62	30	5														
					Pt.				<b>97</b>	<b>96</b>	<b>94</b>	<b>87</b>	<b>78</b>	<b>68</b>	<b>39</b>	<b>19</b>														
60/A	1430	70	112M4	4	Pst.						115	109	104	98	81	68	35													
					Pt.									<b>116</b>	<b>112</b>	<b>107</b>	<b>102</b>	<b>87</b>	<b>78</b>	<b>49</b>										
65/A	1440	73	132SA4	5,5	Pst.								153	143	131	109	87	54	11											
					Pt.											<b>155</b>	<b>146</b>	<b>136</b>	<b>116</b>	<b>97</b>	<b>68</b>	<b>29</b>								
70/A	1440	75	132M4	9,2	Pst.									171	160	148	135	103	47											
					Pt.											<b>175</b>	<b>165</b>	<b>155</b>	<b>146</b>	<b>116</b>	<b>68</b>									
75/A	1440	77	160M4	15	Pst.											208	191	155	101	20										
					Pt.														<b>213</b>	<b>199</b>	<b>165</b>	<b>116</b>	<b>43</b>							
80/A	1455	81	160L4	18,5	Pst.												227	192	163	129	74	9								
					Pt.															<b>233</b>	<b>199</b>	<b>175</b>	<b>146</b>	<b>97</b>	<b>39</b>					
90/A	1465	83	200L4	30	Pst.														264	242	219	176	142	97	43					
					Pt.																	<b>272</b>	<b>252</b>	<b>233</b>	<b>194</b>	<b>165</b>	<b>126</b>	<b>78</b>		
100/A	1440	87	280M4	45	Pst.															313	301	289	256	233	210	167	80			
					Pt.																		<b>320</b>	<b>310</b>	<b>301</b>	<b>272</b>	<b>252</b>	<b>233</b>	<b>194</b>	<b>116</b>

Pst (daPa) = pressione statica - static pressure  
 pression statique - statischer Druck  
 Pt (daPa) = pressione totale - total pressure  
 pression totale - Gesamtdruck

Tolleranza: sulla portata  $\pm 5\%$ , sulla rumorosità  $+3dB(A)$  - Tolerance: capacity  $\pm 5\%$ , noise  $+3dB(A)$  - Tolérance: débit  $\pm 5\%$ , bruit  $+3dB(A)$  - Toleranz: Fördermenge  $\pm 5\%$ , Geräusch  $+3dB(A)$

Le caratteristiche riportate sono riferite al funzionamento con aria a  $+15^{\circ}C$  alla pressione barometrica di 760 mmHg. Peso specifico 1,226 kg/m<sup>3</sup> (caratteristiche in mandata)

The tables show the characteristics of an operating device at air  $+15^{\circ}C$ , barometric pressure 760 mmHg, specific gravity 1,226 kg/m<sup>3</sup> (specifications in discharge stage)

Les caractéristiques mentionnées sont rapportées au fonctionnement avec air  $+15^{\circ}C$  à la pression barométrique de 760 mmHg, poids spécifique 1,226 kg/m<sup>3</sup> (caractéristiques en soufflage)

Die in der Tabelle angezeigten Daten beziehen sich auf Luft bei einer Temperatur von  $+15^{\circ}C$ , barometrischem Druck 760 mmHg und auf ein spezifisches Gewicht der Luft von 1,226 kg/m<sup>3</sup> (eigenschaften druckseitig)

Tipo Type Type Typ SFRK	n° Min. <sup>-1</sup> rpm	Lp dB(A)	Motore Motor Moteur Motor	kW inst.	CARATTERISTICHE - SPECIFICATIONS - CARACTERISTIQUES - EIGENSCHAFTEN SFRK (1000 rpm)																				
					V= m <sup>3</sup> /min																				
					33	41	50	58	66	75	83	100	116	133	166	208	250	291	333	416	500	583	666	750	833
40/C	960	52	80B6	0,55	Pst.	22	15	8	2																
					Pt.	23	16	11	6																
45/C	960	53	80B6	0,55	Pst.		35	29	23	18	9														
					Pt.		36	31	25	21	13														
50/C	960	54	90S6	0,75	Pst.			41	35	32	26	21	15	3											
					Pt.			42	37	34	29	24	19	10											
55/C	960	55	100LA6	1,5	Pst.				43	39	37	34	28	20	11										
					Pt.				44	41	39	36	31	24	16										
60/B	960	61	100LA6	1,5	Pst.				49	48	47	45	41	34	25	4									
					Pt.				50	49	49	48	44	38	31	14									
65/B	960	64	112M6	2,2	Pst.				67	66	61	56	48	34											
					Pt.				68	67	63	58	50	39											
70/B	960	66	132SA6	3	Pst.							76	75	70	62	47	28	4							
					Pt.							78	77	74	67	54	38	17							
75/B	960	68	132MA6	4	Pst.									87	83	72	60	29	4						
					Pt.										89	87	78	68	39	19					
80/B	960	73	132MB6	5,5	Pst.										94	91	82	70	52	13					
					Pt.										97	95	87	78	63	29					
90/B	960	75	160L6	11	Pst.													131	114	87	59	30			
					Pt.																136	121	97	73	49
100/B	960	78	180L6	18,5	Pst.														151	139	117	95	67	39	8
					Pt.																	155	146	126	107

Pst (daPa) = pressione statica - static pressure  
 pression statique - statischer Druck  
 Pt (daPa) = pressione totale - total pressure  
 pression totale - Gesamtdruck

Tipo Type Type Typ SFRK	n° Min. <sup>-1</sup> rpm	Lp dB(A)	Motore Motor Moteur Motor	kW inst.	CARATTERISTICHE - SPECIFICATIONS - CARACTERISTIQUES - EIGENSCHAFTEN SFRK (750 rpm)																			
					V= m <sup>3</sup> /min																			
					33	41	50	58	66	75	83	100	116	133	166	208	250	291	333	416	500	583	666	750
55/D	710	49	100LB8	1,1	Pst.	23	22	20	16	14	11	5												
					Pt.	23	22	20	17	16	13	8												
60/C	710	55	100LB8	1,1	Pst.		27	26	24	23	21	19	13	6										
					Pt.		27	26	25	24	22	20	16	9										
65/C	710	58	112M8	1,5	Pst.			34	33	32	30	25	19	15										
					Pt.			35	34	33	31	26	21	17										
70/C	710	60	132S8	2,2	Pst.				44	43	41	37	35	25	14									
					Pt.				45	44	43	39	37	28	19									
75/C	710	62	132M8	3	Pst.							49	46	36	27	9	2							
					Pt.							50	48	39	31	15	10							
80/C	710	66	160MA8	4	Pst.								55	48	45	33	21	2						
					Pt.								56	49	48	37	26	10						
90/C	710	68	160MB8	5,5	Pst.									69	63	55	44	22						
					Pt.									71	66	58	49	29						
100/C	710	72	160L8	7,5	Pst.										86	78	73	58	41	20	1			
					Pt.										87	81	76	63	48	29	13			

Pst (daPa) = pressione statica - static pressure  
 pression statique - statischer Druck  
 Pt (daPa) = pressione totale - total pressure  
 pression totale - Gesamtdruck

Tolleranza: sulla portata  $\pm 5\%$ , sulla rumorosità  $+3dB(A)$  - Tolerance: capacity  $\pm 5\%$ , noise  $+3dB(A)$  - Tolérance: débit  $\pm 5\%$ , bruit  $+3dB(A)$  - Toleranz: Fördermenge  $\pm 5\%$ , Geräusch  $+3dB(A)$

Le caratteristiche riportate sono riferite al funzionamento con aria a  $+15^\circ C$  alla pressione barometrica di 760 mmHg. Peso specifico 1,226 kg/r<sup>3</sup> (caratteristiche in mandata)  
 The tables show the characteristics of an operating device at air  $+15^\circ C$ , barometric pressure 760 mmHg, specific gravity 1,226 kg/m<sup>3</sup> (specifications in discharge stage)  
 Les caractéristiques mentionnées sont rapportées au fonctionnement avec air  $+15^\circ C$  à la pression barométrique de 760 mmHg, poids spécifique 1,226 kg/m<sup>3</sup> (caractéristiques en soufflage)  
 Die in der Tabelle angezeigten Daten beziehen sich auf Luft bei einer Temperatur von  $+15^\circ C$ , barometrischem Druck 760 mmHg und auf ein spezifisches Gewicht der Luft von 1,226 kg/m<sup>3</sup> (eigenschaften druckseitig)

# ACCESSORI - ACCESSORIES - ACCESSOIRES - ZUBEHÖRTEILE

- GIUNTI ANTIVIBRANTI- VIBRATION-DAMPING - JOINTS ANTIVIBRATOIRES- SCHWINGUNGSDAMPFENDE-

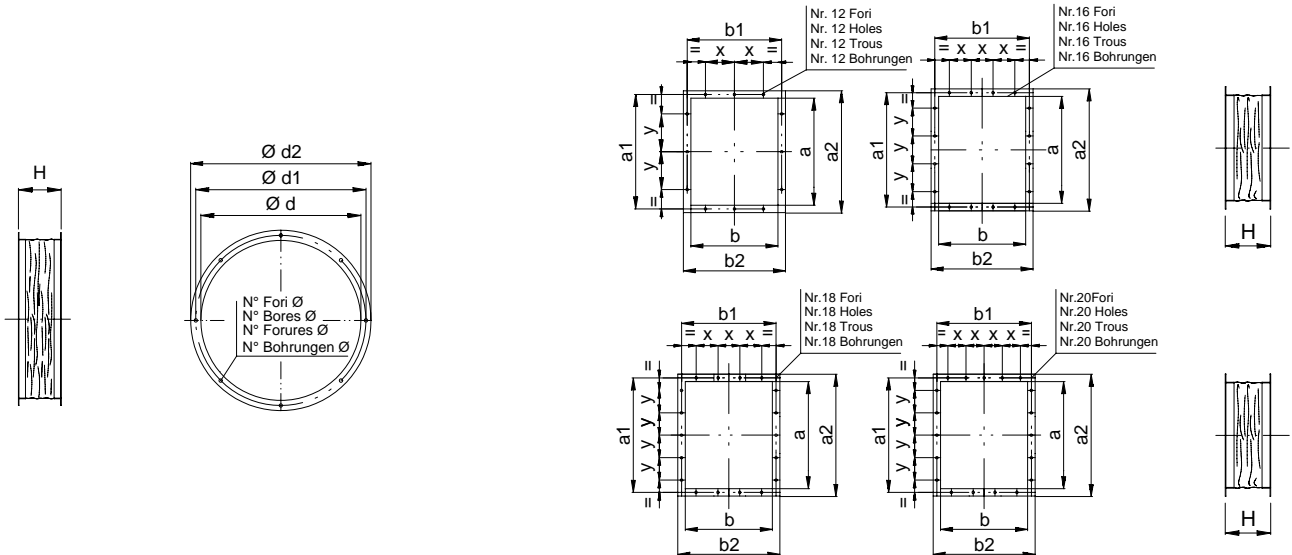

TIPO VENTILATORE TYPE FAN TYPE VENTILATEUR TYP VENTILATOR	SIGLA SERIAL No. SIGLE BEZEICHNUNG	d	d1	d2	H	Fori Holes Trous Bohrungen N° Ø
SCRK - SFRK 40	GA 420	420	450	480	140	8 10
SCRK - SFRK 45	GA 470	470	500	530	140	8 10
SCRK - SFRK 50	GA 520	520	550	580	140	8 10
SCRK - SFRK 55	GA 570	570	610	650	140	16 10
SCRK - SFRK 60	GA 620	620	660	700	140	16 10
SCRK - SFRK 65	GA 670	670	710	750	140	16 10
SCRK - SFRK 70	GA 720	720	760	800	140	16 10
SCRK - SFRK 75	GA 770	770	810	850	140	16 10
SCRK - SFRK 80	GA 820	820	860	900	140	16 12
SCRK - SFRK 90	GA 920	920	960	1000	140	24 12
SCRK - SFRK 100	GA 1020	1020	1060	1100	140	24 12

TIPO VENTILATORE TYPE FAN TYPE VENTILATEUR TYP VENTILATOR	SIGLA SERIAL No. SIGLE BEZEICHNUNG	a	b	a1	a2	b1	b2	x	y	H	Fori Holes Trous Bohrungen N° Ø
SCRK - SFRK 40	GP 400x300	400	300	430	460	350	380	90	140	140	12 10
SCRK - SFRK 45	GP 430x360	430	350	460	490	380	410	115	155	140	12 10
SCRK - SFRK 50	GP 475x400	475	400	505	535	430	460	140	177.5	140	12 10
SCRK - SFRK 55	GP 520x440	520	440	560	600	480	520	110	136.6	140	16 10
SCRK - SFRK 60	GP 580x480	580	480	620	680	520	560	123	157	140	16 10
SCRK - SFRK 65	GP 630x520	630	520	670	710	560	600	137	173	140	16 10
SCRK - SFRK 70	GP 680x560	680	560	720	760	600	640	150	143	140	18 10
SCRK - SFRK 75	GP 730x600	730	600	770	810	640	680	163.3	155	140	18 10
SCRK - SFRK 80	GP 800x640	800	640	840	880	680	720	176.6	172.5	140	20 10
SCRK - SFRK 90	GP 900x720	900	720	940	980	760	800	152.5	197.5	140	20 10
SCRK - SFRK 100	GP 1000x800	1000	800	1050	1100	850	900	175	180	140	20 10

- RETE DI PROTEZIONE ANTINFORTUNISTICA: a maglie passo 12mm. - FILET DE PROTECTION POUR LA PREVENTION DES ACCIDENTS: mailles au pas de 12 mm.  
 - ACCIDENT PREVENTION SAFETY NETTING: with mesh size of 12 mm. - SCHUTZNETZ ZUR UNFALLVERHÜTUNG: mit Maschenweite 12 mm.

TIPO VENTILATORE TYPE FAN TYPE VENTILATEUR TYP VENTILATOR	SIGLA SERIAL No. SIGLE BEZEICHNUNG	Ø A	S	Bracci Arms Bras Flugen N°
SCRK - SFRK 40	RTA 400	450	10	4
SCRK - SFRK 45	RTA 450	500	10	4
SCRK - SFRK 50	RTA 500	550	10	4
SCRK - SFRK 55	RTA 560	610	10	4
SCRK - SFRK 60	RTA 630	660	10	4
SCRK - SFRK 65	RTA 710	710	12	8
SCRK - SFRK 70	RTA 800	800	12	8
SCRK - SFRK 75	RTA 900	890	12	8 + 8
SCRK - SFRK 80	RTA 900	890	12	8 + 8
SCRK - SFRK 90	RTA 1000	1000	12	8 + 8
SCRK - SFRK 100	RTA 1000	1000	12	8 + 8

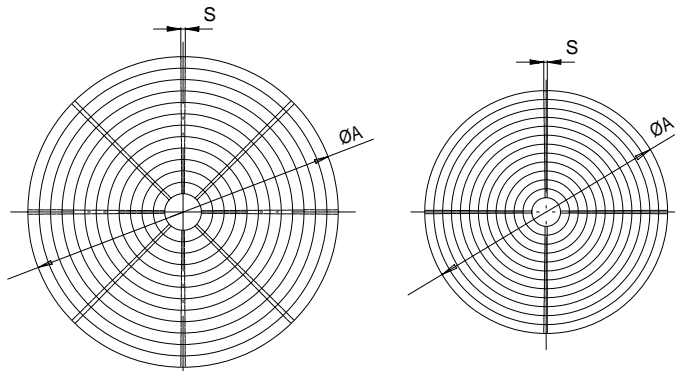

# ACCESSORI - ACCESSORIES - ACCESSOIRES - ZUBEHÖRTEILE

- CONTROFLANGE- COUNTER-FLANGES - CONTRE-BRIDES - GEGENFLANSCHEN -

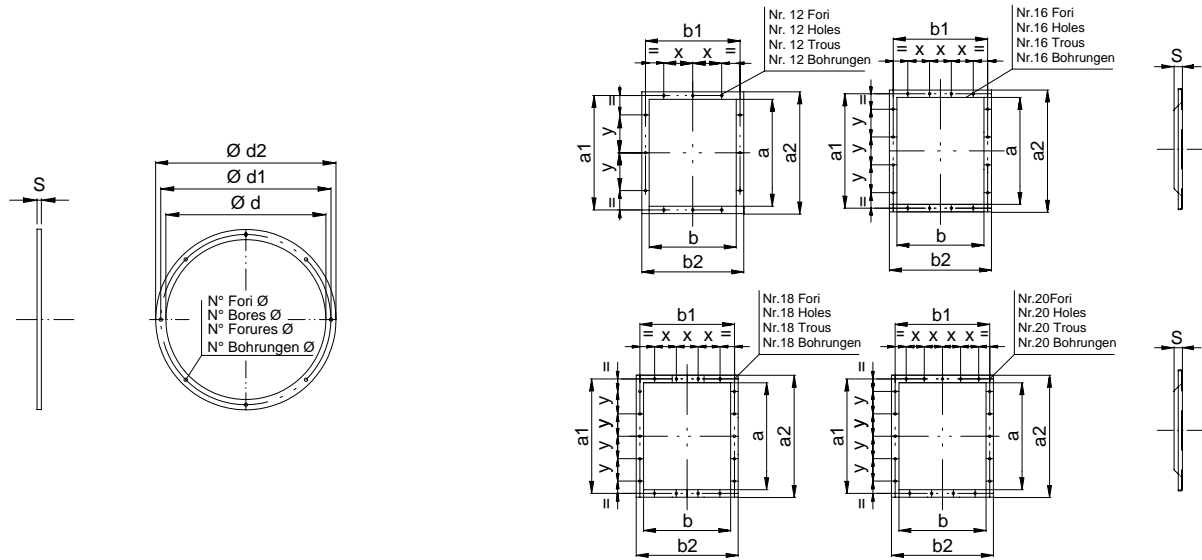

TIPO VENTILATORE TYPE FAN TYPE VENTILATEUR TYP VENTILATOR	SIGLA SERIAL No. SIGLE BEZEICHNUNG	d	d1	d2	S	Fori Holes Trous Bohrungen N°. Ø
SCRK - SFRK 40	FA 420	420	450	480	3	8 10
SCRK - SFRK 45	FA 470	470	500	530	3	8 10
SCRK - SFRK 50	FA 520	520	550	580	3	8 10
SCRK - SFRK 55	FA 570	570	610	650	3	16 10
SCRK - SFRK 60	FA 620	620	660	700	3	16 10
SCRK - SFRK 65	FA 670	670	710	750	3	16 10
SCRK - SFRK 70	FA 720	720	760	800	3	16 10
SCRK - SFRK 75	FA 770	770	810	850	3	16 10
SCRK - SFRK 80	FA 820	820	860	900	3	16 12
SCRK - SFRK 90	FA 920	920	960	1000	3	24 12
SCRK - SFRK 100	FA 1020	1020	1060	1100	3	24 12

TIPO VENTILATORE TYPE FAN TYPE VENTILATEUR TYP VENTILATOR	SIGLA SERIAL No. SIGLE BEZEICHNUNG	a	b	a1	a2	b1	b2	x	y	S	Fori Holes Trous Bohrungen N°. Ø
SCRK - SFRK 40	FP 400x300	400	300	430	460	350	380	90	140	35	12 10
SCRK - SFRK 45	FP 430x360	430	350	460	490	380	410	115	155	35	12 10
SCRK - SFRK 50	FP 475x400	475	400	505	535	430	460	140	177.5	35	12 10
SCRK - SFRK 55	FP 520x440	520	440	560	600	480	520	110	136.6	45	16 10
SCRK - SFRK 60	FP 580x480	580	480	620	680	520	560	123	157	45	16 10
SCRK - SFRK 65	FP 630x520	630	520	670	710	560	600	137	173	45	16 10
SCRK - SFRK 70	FP 680x560	680	560	720	760	600	640	150	143	45	18 10
SCRK - SFRK 75	FP 730x600	730	600	770	810	640	680	163.3	155	45	18 10
SCRK - SFRK 80	FP 800x640	800	640	840	880	680	720	176.6	172.5	45	20 10
SCRK - SFRK 90	FP 900x720	900	720	940	980	760	800	152.5	197.5	45	20 10
SCRK - SFRK 100	FP 1000x800	1000	800	1050	1100	850	900	175	180	45	20 10

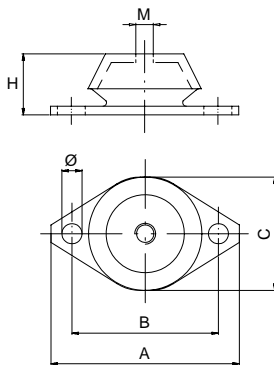

- AMMORTIZZATORI ANTIVIBRANTI: impediscono la trasmissione di vibrazione e rumori alle strutture sono realizzati in materiale metallo gomma speciale. Temperatura di esercizio -20° +80°.
- VIBRATION DAMPERS: prevent noise and vibration transmission to the frameworks, made of special metal rubber material. Working temperature range -20°C to +80°C.
- AMORTISSEURS ANTIVIBRATOIRES: empêchant la transmission des vibrations et du bruit aux structures, réalisés en matière métal-caoutchouc. Température de service de -20°C a +80°C.
- SCHWINGUNGSDÄMPFER: verhindern die Übertragung von Schwingungen und Geräusche an die Strukturen, sind aus speziellem Metall-Gummi-Material hergestellt. Betriebstemperatur -20°C +80°C.

TIPO VENTILATORE TYPE FAN TYPE VENTILATEUR TYP VENTILATOR	SIGLA SERIAL No. SIGLE BEZEICHNUNG	A	B	C	H	M	Ø	Peso Weight Poids Gewicht (Kg.)
SCRK/SFRK 40 - 45	AVFO 25/10	106	84	63	30	M10	Ø8	0.4
SCRK/SFRK 50 - 100	AVFO 25/15	128	111	85	45	M12	Ø11	0.8

- PORTELLO
- INSPECTION DOOR
- PORTE
- ABDECKPLATTE

TIPO VENTILATORE TYPE FAN TYPE VENTILATEUR TYP VENTILATOR	SIGLA SERIAL No. SIGLE BEZEICHNUNG	A	B
SCRK/SFRK 40 - 45	PI 220x200	220	200
SCRK/SFRK 50 - 75	PI 350x350	350	350
SCRK/SFRK 75 - 100	PI 600x500	600	500

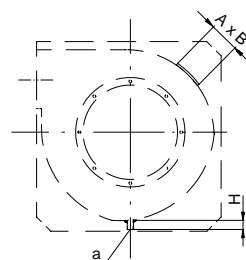

- MANICOTTO DI SCARICO: utilizzato per l'evacuazione dell'eventuale condensa presente nella coclea e viene posizionato nella parte inferiore della coclea stessa.
- EXHAUST SLEEVE: it is used for the drain of any condensation which may be present inside the volute and is positioned in the lower part of the volute itself.
- MANCHON DE DECHARGE: il est utilisé pour évacuer l'éventuelle condensation présente dans la vis et est positionné en la partie inférieure de celle-ci.
- ABLASSMUFFE: wird zum Ablassen des eventuell in der Schnecke vorhandenen Kondenswassers benutzt und ist im unteren Teil derselben angeordnet.

TIPO VENTILATORE TYPE FAN TYPE VENTILATEUR TYP VENTILATOR	SIGLA SERIAL No. SIGLE BEZEICHNUNG	a	H
SFRK 40 - 100	MS 1/2"	1/2" F	35

## ACCESSORI - ACCESSORIES - ACCESSOIRES - ZUBEHÖRTEILE

**CABINA AFONA:** Viene utilizzata per abbattere il livello sonoro generato dalla rotazione della ventola e del motore, inoltre per la protezione contro gli agenti atmosferici del ventilatore nel caso di installazione all'esterno. L'abbattimento sonoro medio è di circa 15 db (A) (per abbattimenti superiori consultare l'ufficio tecnico). La struttura della cabina afona è costituita da: Profilati in alluminio; pannelli (Sp.45 mm.) zincati a doppia parete con interposto lana minerale alta densità, velovetro e interno in lamiera microstirata; basamento in profilati di acciaio.

**SOUNDPROOF CABIN:** This is used to dampen the noise generated by the fan rotation and the motor, and also to protect the fan from weather conditions if it is installed on the outside. The average sound damping is approximately 15 db (A) (for a higher value contact the technical dept.). The soundproof cabin consists of: Aluminium sections; double wall galvanised panels (45 mm thick) with a layer of interposing high-density mineral wool, fiberglass fabric and micro-stretched metal interior Steel section base-plate.

**CABINE APHONE:** Elle est utilisée pour abattre le niveau sonore généré par la rotation du rotor de ventilation et du moteur et également pour protéger le ventilateur des agents atmosphériques, en cas d'installation à l'extérieur. L'abatement sonore moyen est d'environ 15 db (A) (pour des abattements supérieurs, consulter le bureau d'études techniques). La structure de la cabine aphone est constituée par : Des profilés en aluminium; des panneaux (épaisseur de 45 mm) zingués à double paroi, avec interposition de laine minérale à haute densité, voile de verre et intérieur en tôle micro-étirée; une embase en profilés d'acier.

**SCHALLTOTE KABINE:** Diese wird benutzt, um den durch die Rotation des Lüfters und des Motors erzeugten Schallpegel zu reduzieren, sowie als Schutz gegen die Witterungseinflüsse auf den Ventilator bei Installation im Freien. Die durchschnittliche Geräuschreduzierung ist etwa 15 db (A) (bei höherer Reduzierung das technische Büro befragen). Die Struktur der schalltoten Kabine besteht aus: Aluminiumprofilen; tafeln (Stärke 45 mm), verzinkt mit doppelter Wand und darin eingelegter, hochdichter Mineralwolle, Glasfasergewebe und Innenseite aus feingestrecktem Blech; sockel aus Stahlprofilen.

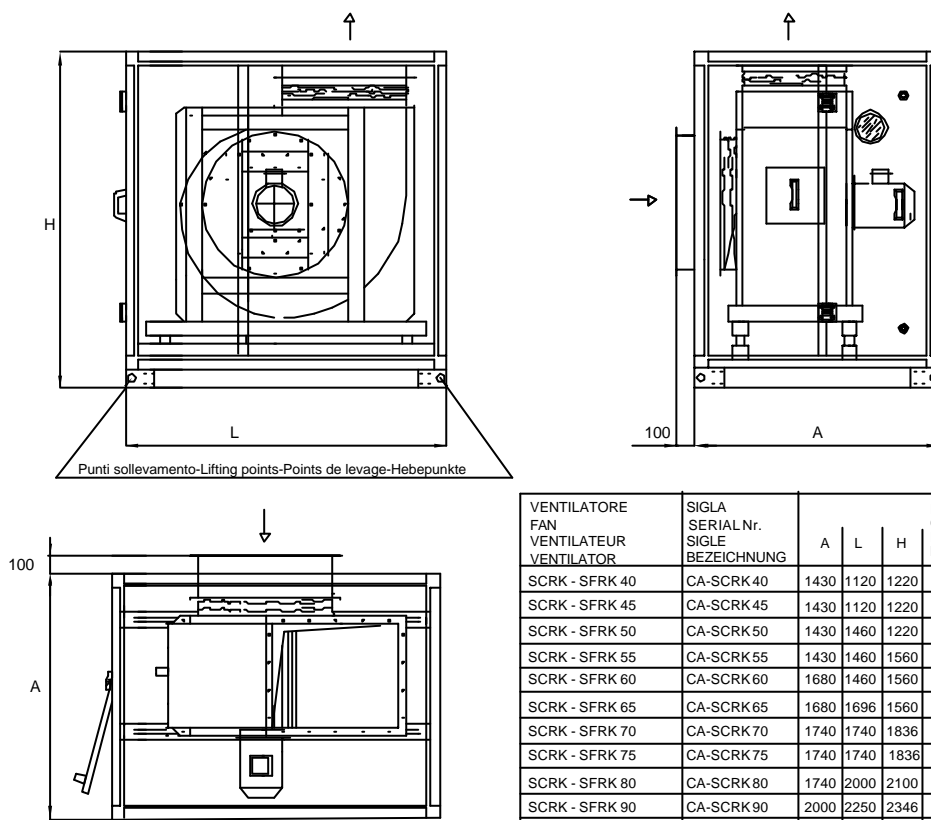

VENTILATORE FAN VENTILATEUR VENTILATOR	SIGLA SERIAL Nr. SIGLE BEZEICHNUNG	A	L	H	Peso cabina Cabin weight Poids cabine kabine ( Kg.)
SCRK - SFRK 40	CA-SCRK 40	1430	1120	1220	200
SCRK - SFRK 45	CA-SCRK 45	1430	1120	1220	200
SCRK - SFRK 50	CA-SCRK 50	1430	1460	1220	255
SCRK - SFRK 55	CA-SCRK 55	1430	1460	1560	300
SCRK - SFRK 60	CA-SCRK 60	1680	1460	1560	300
SCRK - SFRK 65	CA-SCRK 65	1680	1696	1560	340
SCRK - SFRK 70	CA-SCRK 70	1740	1740	1836	365
SCRK - SFRK 75	CA-SCRK 75	1740	1740	1836	365
SCRK - SFRK 80	CA-SCRK 80	1740	2000	2100	420
SCRK - SFRK 90	CA-SCRK 90	2000	2250	2346	420
SCRK - SFRK 100	CA-SCRK 100	2000	2250	2346	540

**Gli orientamenti** del ventilatore eseguibili nella cabina standard sono: LG-RD 0°.

- Gli optional per la cabina sono: microinterruttore di sicurezza per porta, illuminazione interna con interruttore esterno, trave con carrello porta paranco per estrazione motore (alla quota H vanno aggiunti 100 mm.). La cabina viene fornita zincata; a richiesta: verniciatura RAL 5007.

- Il peso è riferito alla sola cabina (senza: ventilatore, motore, e basamento).

- Per ventilatori ad alta temperatura interpellare l'ufficio tecnico. Idonea per ventilatori con trasporto di aria max. 60°C.

**The positions** in which the fan can be directed in the standard cabin are: LG-RD 0°

- Cabin optional:

door safety microswitch, internal lighting with external switch, beam with hoist trolley to remove motor (100 mm are added to H dimension).

- The cabin is supplied galvanised; upon request painted with RAL 5007. The weight refers to the cabin only (without fan, motor and base-plate).

- For high temperature fan contact the technical department. Suitable for fans with an air transfer max 60°C.

**Les orientations** possibles du ventilateur en cabine sont LG-RD 0°.

- Les options de la cabine sont : un micro-interrupteur de sécurité sur la porte, un éclairage intérieur avec interrupteur extérieur, une poutre avec chariot porte-palan pour l'extraction du moteur (100 mm sont ajoutés à la cote H).

- La cabine est zinguée de série. Peinture RAL 5007, sur demande.

- Le poids se réfère à la seule cabine (sans le ventilateur, le moteur et l'embase).

- Pour les ventilateurs à haute température, s'adresser au bureau d'études techniques. Indiquée pour les ventilateurs véhiculant de l'air à une température maximale de 60°C.

**Die in der Standardkabine** ausführbaren Schwenkungen des Lüfters sind die folgenden : LG-RD 0°.

- Optionale Zubehörteile der Kabine: Mikroschalter für Türsicherung, Innenbeleuchtung mit Außenschalter, Träger mit Flaschenzugwagen zum Herausnehmen des Motors (zu Maß H müssen 100 mm hinzugefügt werden). Die Kabine wird verzinkt geliefert ; auf Wunsch: Lackierung RAL 5007. Das Gewicht ist nur auf die Kabine bezogen (ohne Lüfter, Motor und Sockel).

- Für Ventilator mit hohen Temperaturen bitte das technische Büro befragen. Geeignet für Ventilator mit Lufttransport max. 60°C.

- **Tabella non impegnativa - The above data are unbinding - Tableau sans engagement - Mabe unverbindlich.**







Via Reggio Calabria,13 – Cascine Vica Rivoli (TO) Italia  
 Tel: (+39) 011. 959.16.01 Fax: (+39) 011. 959.29.62  
 E-mail : savio@savioclima.it [http:// www.savioclima.it](http://www.savioclima.it)

